



## Combination controls

CG 10



## Combination controls CG 10

- // Complete with strainer, two solenoid valves and servo-governor for maximum regulation precision.
- // Special low-noise valves.
- // Optional pressure switch at the inlet.
- // Easy-to-service. All adjustment and metering facilities, with the addition of the electrical connections, are accessible from one side.
- // Flow rate adjustment for precise adjustment of the max. flow rate.
- // Environment-friendly thanks to recyclable and resource-friendly design, plastic parts with material identification.
- // EC type-tested and certified design.
- // CE



### Application

For safeguarding and controlling atmospheric burners, forced draught gas burners and induced-draught boilers on heating installations up to 50 kW.

Combination controls CG..G, CG..V2 and CG..V3 can also be used on steam boiler installations to TRD 412.

The combination controls are EC type-tested and certified pursuant to the Gas Appliance Directive (2009/142/EC) in conjunction with EN 126.

### Examples of application

#### CG..D1 CG..D2

Single-stage, special-purpose gas heating boilers, single-stage wall heating boilers, pre-mixers.

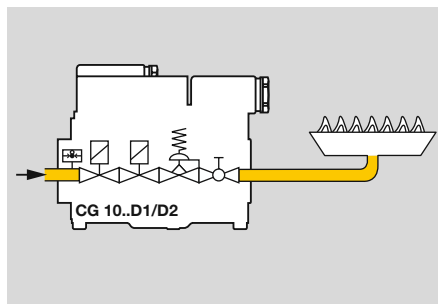
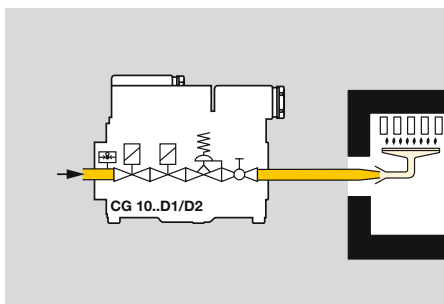

#### CG..D1 CG..D2

Hearths.

#### CG..D1 CG..D2

Units, single-stage forced draught gas burners, burners with mechanical capacity adjustment.

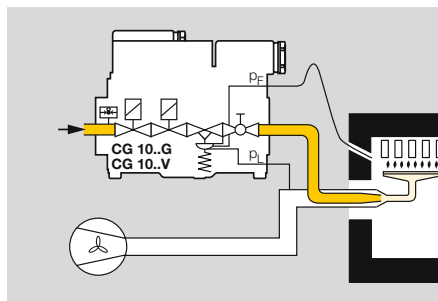
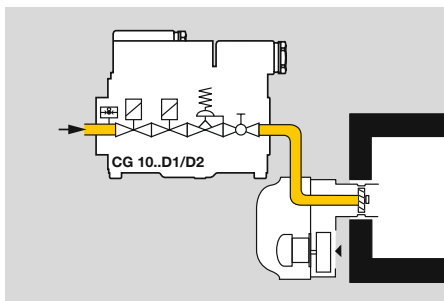

#### CG..G\*

Draught-assisted boilers, modulating or multi-stage control.

#### CG..V

Fan and draught-assisted boilers, modulating or two-stage control.

#### CG..D1 CG..D2

Radiant plaques, industrial heating systems, radiant tube heaters, space heaters.

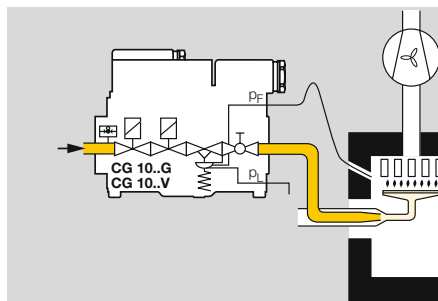
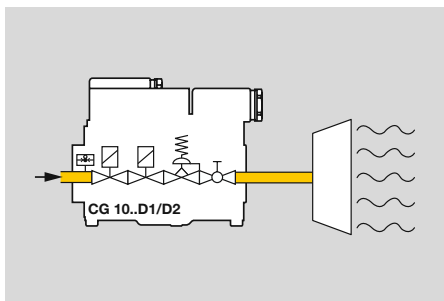

#### CG..G\*

Boilers with flue-gas, induced-draught fan.

#### CG..V

Boilers with flue-gas induced-draught fan.

\*CG..G without connection for combustion chamber pressure  $p_F$

#### CG..E

Boiler with air/gas pre-mixed in the forced draught fan.

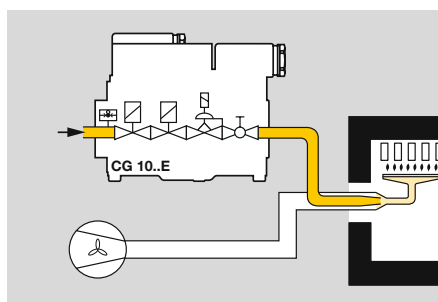
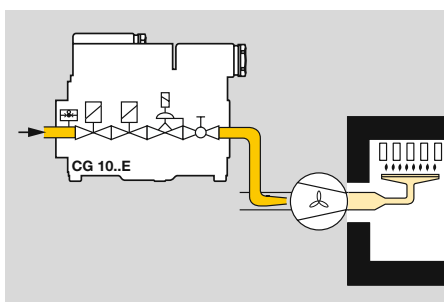

#### CG..E

Boiler with air/gas pre-mixed after the forced draught fan.

**CG..G\***  
Forced draught  
burners, modulat-  
ing or two-stage  
control.

**CG..V**  
Forced draught  
burners, modulat-  
ing or multi-stage  
control.

\* CG..G without con-  
nection for combustion  
chamber pressure  $p_F$

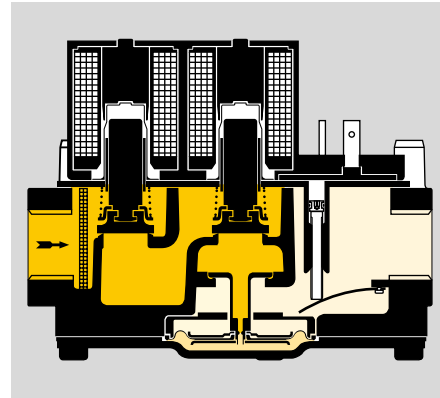
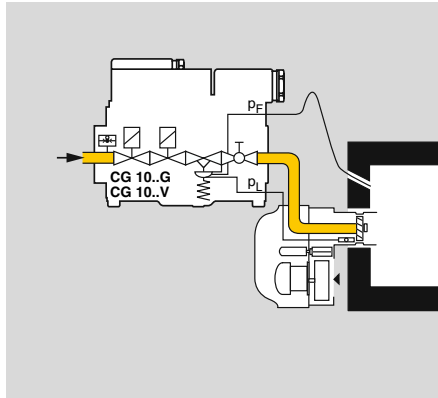

**Function**  
When the voltage  
is applied, the two  
solenoid valves  
open. The servo-  
governor achieves  
a high regulating  
precision regard-  
less of changing  
inlet pressures.

**Features**

- 2 solenoid valves, class A or B.
- CG..D1 with constant pressure governor.
- CG..D2 with constant pressure governor with start load.
- CG..G with air/gas ratio control, ratio of gas pressure to air pressure 1:1.

- CG..V2 and CG..V3 with variable air/gas ratio control, ratio of gas pressure to air pressure 2:1 or 3:1.
- CG..E with electronic governor.
- Inlet pressure switch DG..C can be fitted at the works (cannot be fitted retrospectively).
- With flow rate adjustment.

**Technical data**

Types of gas: natural gas and LPG (gaseous).  
Inlet pressure range  $p_e$ :  
15 to 70 mbar.  
Ambient temperature: 0 to +60°C.  
Storage temperature: -20 to +50°C.  
Threaded connection: Rp 1/2 in accordance with ISO 7-1.  
Threaded connection, control lines  $p_L$ ,  $p_F$ : 1/8" (CG..G, CG..V2 and CG..V3 only)  
Pressure test points on inlet and outlet.  
Housing components: AISi.  
Diaphragms: Perbunan.  
Strainer: plastic fabric.  
Solenoid valves (class A or B) with spring-loaded valve disc, normally closed (when de-energised).  
Switching frequency: any.  
Closing time: <1 s.

Mains voltage:  
230 V, -15/+10 %, 50/60 Hz,  $\cos \phi = 1$   
206 V, -15/+10 %, DC voltage  
24 V,  $\pm 15$  %, 50/60 Hz,  $\cos \phi = 1$   
20 V,  $\pm 15$  %, DC voltage.  
Power consumption:  
A valves: 24 W, B valves: 18 W  
The electrical power is the same when switching on as in continuous operation.  
Duty cycle: 100 % duty.  
Protective grade IP 54 in accordance with IEC 529.  
Fusing: max. 6.3 A, slow-blowing.  
Electrical connection:  
Coupler plug in accordance with ISO 4400 with cable gland: Pg 11.

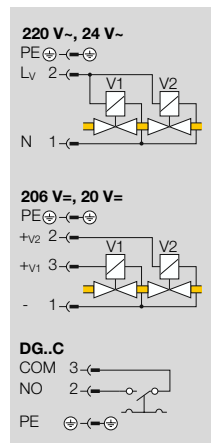

**Fitting position**

In vertical pipework: as required;  
in horizontal pipework: inclined up to max. 90° to left/right, not upside-down, see also CG..D2: Function.

Type	Connection	Dimensions								$p_e$ max.	P	Weight
		DN	L mm	H1* mm	H2 mm	H3 mm	B1 mm	B2 mm	B3 mm			
CG 10..A	Rp 1/2	15	116	74	64	33	30	63	80	70	24	1,4
CG 10..B	Rp 1/2	15	116	59	64	33	30	63	80	70	18	1,2

\* with rectifier adapter H1+22 mm

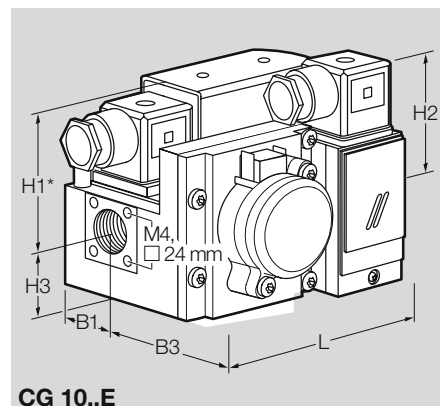
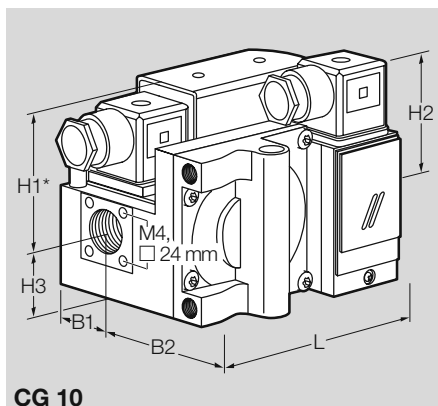

**CG..D1, CG..D2**

With constant governor, class C, for high regulating precision, for atmospheric burners or single-stage forced draught gas burners.

**Function**

Both valves open when the voltage is applied.

CG..D1: The outlet pressure rises to  $p_G$ .

CG..D2: The outlet pressure initially rises to the start pressure  $p_S$ . This is then followed by a damped pressure rise to  $p_G$ .

In fitting position "governor pointing downwards", the pressure remains constant for max. 6 sec. when the start pressure  $p_S$  is reached. Only then does a damped pressure rise to  $p_G$  occur.

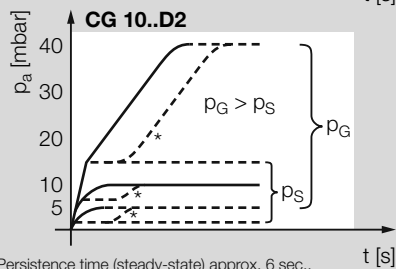
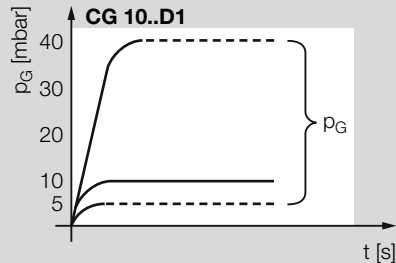
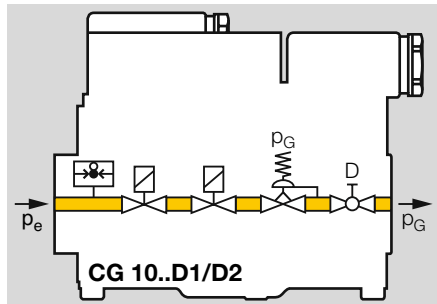
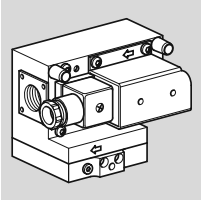

**Working range**

CG..D1: The outlet pressure  $p_G$  can be adjusted by means of a spring from 5 to 40 mbar (CG..D1-20: 2.5-20 mbar).

CG..D2: The start pressure  $p_S$  can be adjusted from 2 to 15 mbar; the outlet pressure  $p_G$  can be adjusted from 5 to 40 mbar (CG..D2-20:  $p_S$ : 1-7.5 mbar,  $p_G$ : 2.5-20 mbar).

\*Persistence time (steady-state) approx. 6 sec., only with fitting position "governor pointing downwards"

**CG..G, CG..V2 and CG..V3**

With constant governor or variable air/gas ratio control, class C, for precise pneumatic air/gas ratio control for modulating or two-stage, sliding draught burners or draught-assisted boilers.

**Function**

Both valves open when the voltage is applied. The CG then regulates the gas outlet pressure  $p_G$ . This pressure follows the variable air control pressure  $p_L$ . The ratio between gas and air pressure remains constant.

At min.-flow operation of the burner, the gas/air mixture can be varied through parallel shifting of the characteristic by adjusting the screw "N". High fire is adjusted with the main flow restrictor D. On the CG..V2 and CG..V3, the combustion chamber pressure can be compensated for by connection to  $p_F$ .

**Working range**

Permitted gas outlet pressure:

$p_G = 0.4$  to 30 mbar.

Permitted air control pressure:

$p_L = 0.4$  to 10 mbar.

Zero offset N:

CG..G:  $\pm 0.2$  mbar

CG..V2:  $\pm 0.4$  mbar

CG..V3:  $\pm 0.6$  mbar

Gas/air ratios:

CG..G: approx. 1:1

CG..V2: approx. 2:1

CG..V3: approx. 3:1

Permitted combustion chamber pressure:

$p_F = -2$  to +5 mbar.

Minimum control pressure difference:

$p_L - p_F = 0.4$  mbar.

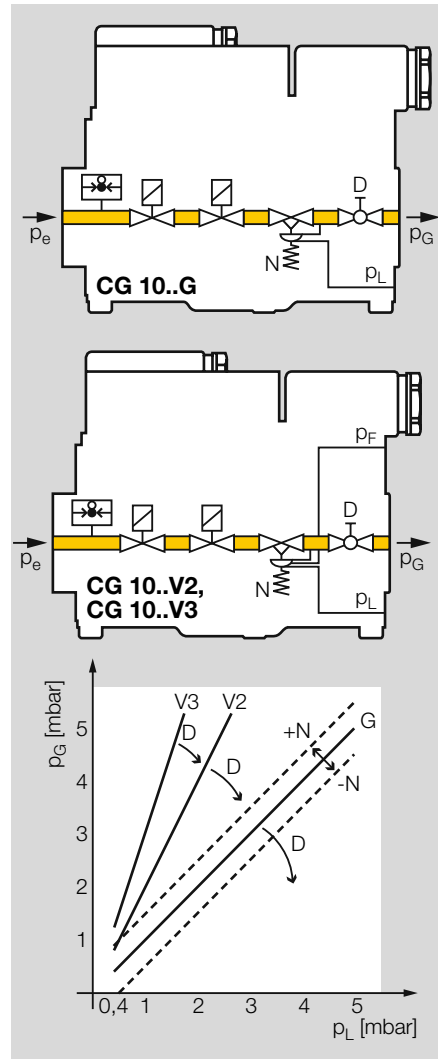

**CG..E**

With electronic governor class C, for precise air/gas ratio control for modulating or two-stage, sliding draught burners or draught-assisted boilers.

**Function**

Both valves open when the voltage is applied. Then the gas outlet pressure  $p_G$  is produced via the control current. The flow rate is set via the main flow restrictor D.

**Working range**

Permitted gas outlet pressure:  
 $p_G = 0.4$  to 12 mbar.  
 Maximum control current: 150 mA.  
 Minimum required control current:  
 Depending on installation position 10 to 45 mA.  
 Maximum power consumption: 2.5 W.

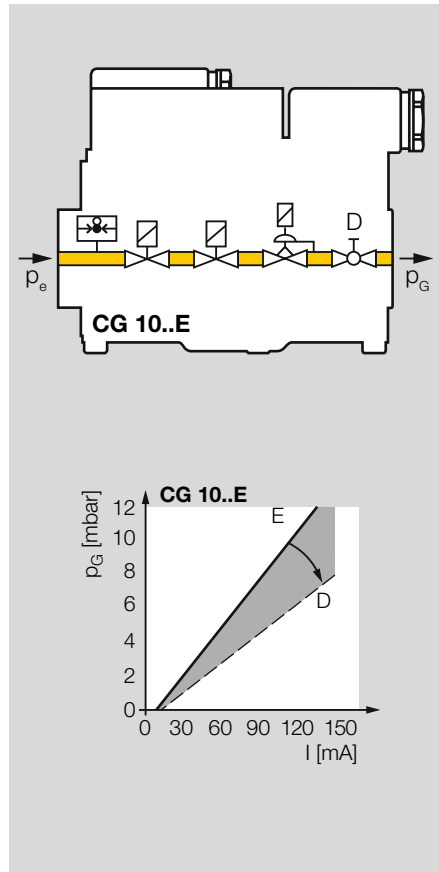

**Selection examples**

Outlet data:

- Type of gas: natural gas
- Min. inlet pressure  $p_e$ : 18 mbar
- Max. flow rate  $V_{max}$ : 2 m<sup>3</sup>/h
- Max. outlet pressure  $p_G$ : 10 mbar

**CG..D1, CG..D2, CG..E**

The pressure drop  $\Delta p$  across the entire combination control can be calculated as follows:

$$\begin{aligned} \Delta p &= p_e - p_G \\ &= 18 - 10 \text{ mbar} \\ &= 8 \text{ mbar} \end{aligned}$$

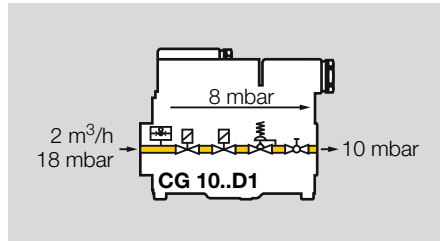

The operating point P1 ( $V_{max} = 2 \text{ m}^3/\text{h}$ ;  $\Delta p = 8 \text{ mbar}$ ) must lie in the working range of the combination control CG 10.

**CG..G, CG..V2, CG..V3**

- Additional outlet data
- Max. burner air pressure  $p_L$ : 4 mbar

Determining the transmission ratio U:

$$U = \frac{p_G}{p_L} = \frac{10}{4} = 2,5$$

Select the governor type with the next higher ratio  $U_{min}$ .

- Governor "G"  $\rightarrow U_{min} = 1.0$  ( $U_{max} = 1.0$ )
- Governor "V2"  $\rightarrow U_{min} = 1.9$  ( $U_{max} = 2.3$ )
- Governor "V3"  $\rightarrow U_{min} = 2.9$  ( $U_{max} = 3.5$ )

The available pressure drop  $\Delta p$  can be calculated as follows:

$$\begin{aligned} \Delta p &= p_e - U_{max} \cdot p_L \\ &= 18 - 3,5 \cdot 4 \text{ mbar} \\ &= 4 \text{ mbar} \end{aligned}$$

The operating point P2 ( $V_{max} = 2 \text{ m}^3/\text{h}$ ;  $\Delta p = 4 \text{ mbar}$ ) must lie in the working range of the combination control CG 10.

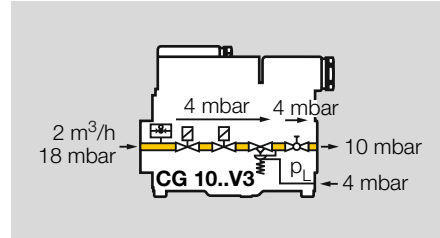

A further 4 mbar must be generated by flow rate adjustment, in addition to the computed pressure drop  $\Delta p = 4 \text{ mbar}$ , in order to achieve the required outlet pressure  $p_G = 10 \text{ mbar}$ .

At min. flow, the actual flow rate may not drop below the minimum flow rate  $V_{min}$  (see diagram).

**All GC units**

If the operating point does not lie in the working range of the CG 10, the inlet variables  $p_e$ ,  $V$ ,  $p_G$  or  $p_L$  must be adapted.

We recommend a different CG control for applications with different capacity demand. See also CG 1, 2, 3, Brochure No. 5.1.2.2.

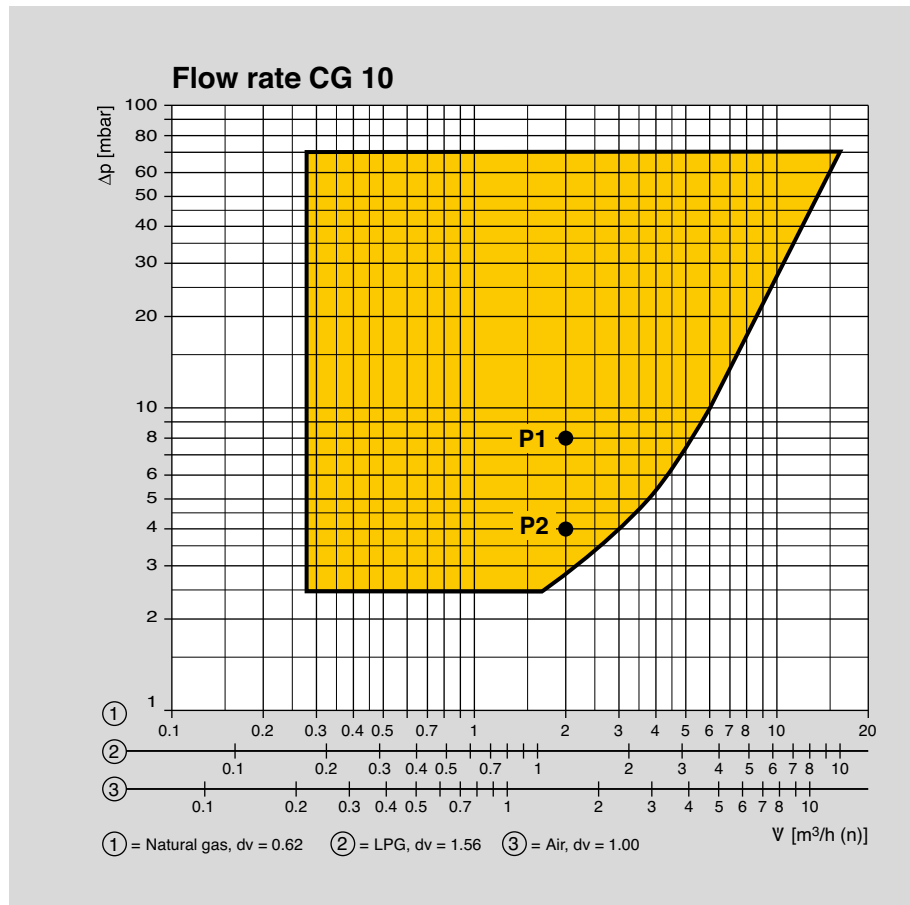



### Accessories

Combination control CG 10 can be fitted at the works with a preset pressure switch for gas DG..C at the inlet as a low-pressure gas cut-out.  
Pre-setting: 14 mbar.

Electrical connection: coupler plug in accordance with ISO 4400 with cable gland Pg 11. Flanges DN 15, straight version or angle version available.  
Both a rectifier adapter for interconnection and a coupler plug with rectifier are available for AC voltage.

### Type code

Type	CG 10 R 70 -D1-20* T 6 A W** Z**
Size 10	
Rp thread	
Max. inlet pressure $p_e$ 70 mbar = 70	
Governor = D1	
Governor with start gas stage = D2	
Air/gas ratio control = G	
Variable air/gas-ratio control 2:1 = V2	
Variable air/gas-ratio control 3:1 = V3	
Electronic governor = E	
Max. outlet pressure $p_G$ with D1 and D2: 20 mbar = 20*	
Mains voltage	20 V $\sim$ = L 24 V $\sim$ = H 206 V $\sim$ = U 110 V $\sim$ = M 230 V $\sim$ = W
Rectifier adapter without socket = 5	
Rectifier adapter with socket = 6	
Without rectifier, without socket = 8	
Without rectifier, with socket = 9	
Valve class = A, B	
Pressure switch DG 35C = W*, DG 45/VC = WW**	
Special version = Z**	

\*  $p_G$  = 40 mbar if "none".

\*\* This letter is omitted if "none".

We reserve the right to make technical modifications in the interests of progress.

Elster has an environment-friendly production policy. Please send away for our Environment Report.

Elster GmbH  
Postfach 2809  
D-49018 Osnabrück  
Phone ++49 (0)5 41/12 14-0  
Fax ++49 (0)5 41/1 21 4-3 70  
info@kromschroeder.com  
www.kromschroeder.de