



Gas Burner Controls

LGA...

The gas burner controls are used for supervision, startup and control of atmospheric gas burners of small to medium capacity without a fan in intermittent operation.

The LGA... and this Data Sheet are intended for use by OEMs which integrate the gas burner controls in their products.

Use, features

The LGA are designed for startup and supervision of atmospheric gas burners in intermittent operation. The flame is supervised with an ionization probe.

- Burner controls for gas burners and gas units with or without fan to EN 298: 1994-02 or EN 298: 1993

General features

- Undervoltage detection
- Air pressure supervision with functional check of the air pressure switch during startup and operation

Special features

LGA41.173A27 and LGA52.171B27 are suitable for use with air heaters.



Note!
Do not use for new designs.



Note!
The following burner controls can be used for new designs:

- LME1...
- LME2...
- LME3...
- LME4...

Warning notes



To avoid injury to persons, damage to property and the environment, the following warning notes must be observed!

Do not open, interfere with or modify the unit.

- All activities (mounting, installation and service work, etc.) must be performed by qualified staff
- Before making any wiring changes in the connection area, completely isolate the plant from mains supply (all-polar disconnection). Ensure that the plant cannot be inadvertently switched on again and that it is indeed dead. If not observed, there is a risk of electric shock hazard
- Ensure protection against electric shock hazard by providing appropriate protection for the burner control's connections terminals. If this is not observed, there is a risk of electric shock
- Each time work has been carried out (mounting, installation, service work, etc.), check to ensure that wiring is in an orderly state and make the safety checks as described in «Commissioning notes. If this is not observed, there is a risk of loss of safety functions and a risk of electric shock
- Press the lockout reset button / operating button only manually (applying a force of no more than 10 N), without using any tools or pointed objects. If this is not observed, there is a risk of loss of safety functions and a risk of electric shock
- Fall or shock can adversely affect the safety functions. Such units must not be put into operation even if they do not exhibit any damage.
If this is not observed, there is a risk of loss of safety functions and a risk of electric shock



Attention!

Earth the burner in compliance with the relevant regulations; earthing the boiler alone does not suffice!

Mounting notes

Ensure that the relevant national safety regulations are complied with.

Positioning the ionization probe

The ionization probe and ignition electrode must be positioned so that the ignition spark cannot arc over to the ionization probe.

- Always run the high-voltage ignition cables separate from the unit and other cables while observing the greatest possible distances
- Make absolutely certain that life and neutral conductors are correctly connected to terminals 1 and 2 of the burner control; otherwise, no flame signal will be generated
- Ensure that the maximum permissible current load for the connecting terminals is not exceeded (refer to *Technical data*)
- Install switches, fuses, earthing, etc., in compliance with local regulations
- The connection diagrams shown apply to burner controls with earthed neutral conductor. In the case of ionization current supervision in networks with nonearthed neutral conductor, terminal 2 must be connected to the earth conductor via an RC unit (part no. ARC 4 668 9066 0). In that case, it must be made certain that the relevant national safety regulations are complied with (e.g. electric shock hazard protection), since AC 230 V / 50 Hz mains voltage results in a leakage current of 2.7 mA
- Make certain that the maximum permissible current rating of the connection terminals will not be exceeded
- Do not feed external mains voltage to the control outputs of the unit. When testing the devices controlled by the burner control (fuel valves, etc.), the LGA... must not be connected
- To isolate the burner control from the mains supply, use an all-polar switch with a contact gap of at least 3 mm
- Secure the earthing lug in the terminal base with a metric screw and a lockwasher or similar
- Switches, fuses, earthing, etc., must be in compliance with local regulations; primary fuse max. 10 A slow
- Connect the gas pressure switch and controller, whose contacts must be closed from startup to controlled shutdown, in series with control thermostat or pressurestat (R) and limit thermostat or pressure switch (W)
- For safety reasons, feed the neutral conductor to the neutral distributor in the plug-in base, or to terminal 2. Connect the burner components (fan, ignition transformer and gas valves) as represented in the figure 7435a14, to the neutral distributor as shown below. The connection between neutral conductor and terminal 2 is prewired in the terminal base

Example

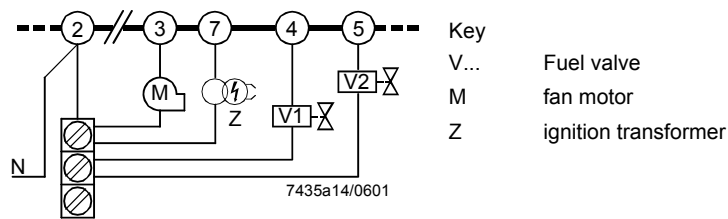

Correct wiring of neutral conductors!

Only with LGA41...

- If the fully closed position of the main valve «BV2» shall be checked on burner startup, the closed position contact must be included in the loop between terminals 9 and 3. In addition, the connecting links between terminals 9 and 11 and 8 and 3 must be fitted
- During the startup sequence, terminal 6 carries voltage and must not be used as an auxiliary terminal
- The auxiliary contact of a gas valve for checking the fully closed position must be included in the loop between terminals 9 and 3

Only with LGA52... / LGA63...

- During the startup sequence, terminals 9 and 6 carry voltage and must not be used as auxiliary terminals
- Connect the load controller of 2-stage burners to terminal 5 in series with «BV2»

Electrical connection of ionization probe

It is important to achieve practically disturbance- and loss-free signal transmission:

- Never run the detector cable together with other cables
 - Line capacitance reduces the magnitude of the flame signal
 - Use a separate cable
- Observe the permissible length of the detector cable (refer to «Technical data»)
- The ionization probe and the ignition electrode are not protected against electric shock hazard
- Locate the ignition electrode and the ionization probe such that the ignition spark cannot arc over to the ionization probe (risk of electrical overloads) and that it cannot adversely affect the supervision of ionization
- With ionization current supervision, the cable length for flame detection must not exceed 20 m
- Insulation resistance
 - Must be a minimum of 50 MΩ between ionization probe and ground even after a large number of operating hours
 - Prerequisite for this is not only high quality heat-resistant insulation of the electrode cable, but also of the ionization probe itself (ceramic holder!)
 - Soiled detector holders reduce the insulation resistance, thus supporting creepage currents
- The burner (as the counter-electrode) must be correctly earthed, or else no ionization current will flow
- Since the burner bars form the earthed counter-electrode, the burner must be adjusted so that the flame is hot and stable and in firm contact with the burner bars. With pulsating flames or yellow-burning flames resulting from lack of air, a very low or even no ionization current is generated so that the burner enters malfunction

Commissioning notes

When commissioning the plant or when doing maintenance work, make the following safety checks:

| | Safety check to be carried out | Anticipated response |
|----|--|--|
| a) | Burner startup with no flame signal; for that purpose, open the connection between burner control and ionization probe prior to burner startup and maintain that status | Lockout at the end of «TSA» |
| b) | Burner operation with simulated loss of flame during operation; for that purpose, open the connection between burner control and ionization probe during burner operation and maintain that status | Restart, followed by lockout at the end of «TSA» |
| c) | No air pressure signal during «t1» (only with LGA52... / LGA63... with auxiliary fan) | No startup |
| d) | Air pressure failure during operation (only with LGA52... / LGA63... with auxiliary fan) | Shutdown |

Standards and certificates



Applied directives:

- Directive for gas-fired appliances 2009/142/EC
- Electromagnetic compatibility EMC (immunity) *) 2004/108/EC

*) The compliance with EMC emission requirements must be checked after the burner control is installed in equipment

Compliance with the regulations of the applied directives is verified by the adherence to the following standards / regulations:

- Automatic burner control systems for burners and appliances burning gaseous or liquid fuels DIN EN 298:1994

The relevant valid edition of the standards can be found in the declaration of conformity!



EAC Conformity mark (Eurasian Conformity mark)



ISO 9001:2008
ISO 14001:2004
OHSAS 18001:2007



China RoHS
Hazardous substances table:
<http://www.siemens.com/download?A6V10883536>

Identification code to EN 298

- Single-stage **A M C L X N**
- 2-stage **A T C L X N**

Life cycle

Burner controls has a designed lifetime* of 250,000 burner startup cycles which, under normal operating conditions in heating mode, correspond to approx. 10 years of usage (starting from the production date given on the type field).

This lifetime is based on the endurance tests in the standard EN 298. A summary of the conditions has been published by the European Control Manufacturers Association (Afecor) (www.afecor.org).

The designed lifetime is based on use of the burner controls according to the manufacturer's Data Sheet. After reaching the designed lifetime in terms of the number of burner startup cycles, or the respective time of usage, the burner control is to be replaced by authorized personnel.

* The designed lifetime is not the warranty time specified in the Terms of Delivery

Disposal notes



The unit contains electrical and electronic components and must not be disposed of together with household waste. Local and currently valid legislation must be observed.

Mechanical design

The gas burner controls are of plug-in design, suitable for installation in any position on burners, in control cabinets or on control panels.

The housing is made of impact-proof, heat resistant and flame-retarding plastic. It is of plug-in design (measuring 91 x 62 x 63 mm, including the plug-in base) and engages audibly in the plug-in base.

The color of plastic material of burner controls LGA are executed in black.

The housing accommodates the ...

- ... the thermal sequencing device (ambient temperature-compensated) acting on a multiple snap action switching system,
- ... flame signal amplifier with the flame relay
- ... lockout reset button with its integrated signal lamp (splash-proof)

Undervoltage detection

In the event mains voltage drops below about AC 165 V, an electronic circuit ensures that the gas burner control will prevent burner startup or – without releasing fuel – lockout will be initiated.

Only with
LGA63.191A27

- Undervoltage threshold: AC 178 V ±10 V
- «TSA»: Smaller tolerance band
- Flame signal amplifier: Higher sensitivity, for typical applications with pilot flames

Type summary

The type references given in the table refer to gas burner controls with no base and no accessories.

For ordering information for plug-in bases and other accessories, see *Accessories*.

| Article no. | Type | Mains voltage | Burner with undervoltage detection | Connection facility for auxiliary fan ¹⁾ | Connection facility for air pressure switch | Control outputs for gas valves | Reversed polarity protection |
|------------------|---------------------|----------------|------------------------------------|---|---|--------------------------------|------------------------------|
| BPZ:LGA41.153A27 | LGA41.153A27 | AC 220...240 V | --- | • | • | 2 | • |
| BPZ:LGA52.150B17 | LGA52.150B17 | AC 100...110 V | • | | | 2 | • |
| BPZ:LGA41.173A27 | LGA41.173A27 | AC 220...240 V | • | | | 2 | • |
| BPZ:LGA52.150B27 | LGA52.150B27 | AC 220...240 V | • | | | 2 | • |
| BPZ:LGA52.171B27 | LGA52.171B27 | AC 220...240 V | • | • | • | 2 | • |
| BPZ:LGA63.191A27 | LGA63.191A27 | AC 230 V | • | • | • | 2 | • |

1) Auxiliary fan not monitored to EN 298

Accessories (must be ordered separately)

Connection accessories for small burner controls

Plug-in base **AGK11...**
To connect the small-capacity burner controls to the burner plant.
See Data Sheet N7201



Cable holders **AGK66...**
Cable holder for plug-in base AGK11
See Data Sheet N7201



Cable holders **AGK65...**
Cable holder for plug-in base AGK11
See Data Sheet N7201



Flame detector

Ionization probe
Supplied by thirds



Actuators

Actuator **SQN3...**
See Data Sheet N7808



Actuator **SQN7...**
See Data Sheet N7804



Actuator **SQN9...**
See Data Sheet N7806



Others

RC unit **ARC 4 668 9066 0**
Article no.: **BPZ:ARC466890660**
For the supervision of ionization currents in networks with nonearthed neutral conductor



Technical data

| | | |
|-----------------------|--|--|
| General unit data | Mains voltage | AC 220 V –15 %...AC 240 V +10 % AC 100 V –15 %...AC 110 V +10 % |
| | - Only with LGA63... | AC 230 ±10 % |
| | Mains frequency | 50...60 Hz ±6 % |
| | Power consumption | 3 VA |
| | Perm. mounting position | Optional |
| | Degree of protection | IP40 (when integrated) |
| | Safety class | I (burner control with plug-in base) |
| | Input current at terminal 1 | Max. 5 A |
| | Permissible cable lengths Detector cable, laid separately | Max. 3 m with 100 pF/m line capacitance |
| | Perm. electrical rating | |
| | - Terminal 4 | Max. 4 A |
| | - Terminal 5 | Max. 1 A |
| | - Terminal 6 | Max. 2 A |
| | - Terminal 7 | Max. 2 A |
| | - Terminal 8 | Max. 4 A |
| | - Terminal 9 | Max. 0,1 A |
| | - Terminal 10 | Max. 1 A |
| | Cable length terminal | 20 m at 100 pF/m |
| | Weight | Approx. 180 g |
| | Environmental conditions | Storage |
| Climatic conditions | | Class 1K3 |
| Mechanical conditions | | Class 1M2 |
| Temperature range | | -20...+60 °C |
| Humidity | | <95 % r.h. |
| Transport | | DIN EN 60721-3-2 |
| Climatic conditions | | Class 2K2 |
| Mechanical conditions | | Class 2M2 |
| Temperature range | | -50...+60 °C |
| Humidity | | <95 % r.h. |
| Operation | | DIN EN 60721-3-3 |
| Climatic conditions | | Class 3K5 |
| Mechanical conditions | | Class 3M2 |
| Temperature range | | 0...+60 °C For LGA41.173A27 and LGA52.171B27: -20...+60 °C |
| Humidity | <95 % r.h. | |
| Installation altitude | Max. 2,000 m above sea level | |



Caution!

Condensation, formation of ice and ingress of water are not permitted!
If this is not observed, there is a risk of loss of safety functions and a risk of electric shock.

Flame supervision

Flame supervision with ionization probe

| At mains voltage UN = AC 230 V | |
|---|----------------------------|
| Detector voltage between terminals 1 and 2 or ground (AC voltmeter $R_i \geq 10 \text{ M}\Omega$) | $\leq UN$ |
| Recommended detector current to ensure reliable operation | Min. 5 μA |
| Possible detector current in operation | Max. 100 μA |
| Length of detector cable | Max. 20 m (separate cable) |
| Required insulation resistance between ionization probe with its cable and ground | Min. 50 $\text{M}\Omega$ |

The conductivity and rectifying effect of hot flame gases are used for flame supervision. For that purpose, AC voltage is applied to the heat-resistant ionization probe which projects into the flame. The current that flows in the presence of a flame (ionization current) generates the flame signal which is fed to the input of the flame signal amplifier. The amplifier is designed so that it only responds to the DC current component of the flame signal, thereby ensuring that a short-circuit between ionization probe and ground cannot simulate a flame signal (since AC current would flow in this case).

Ionization current supervision with AC 110 V burner controls

Since the ionization current with AC 110 V burner controls is only around half of those operating on AC 230 V, the detector voltage must be increased with a transformer in certain cases.

Capacity of transformer: Min. 2 VA

Transforming ratio: Approx. 1.1...1.5

The primary and secondary windings must be galvanically separated.

Connection of transformer

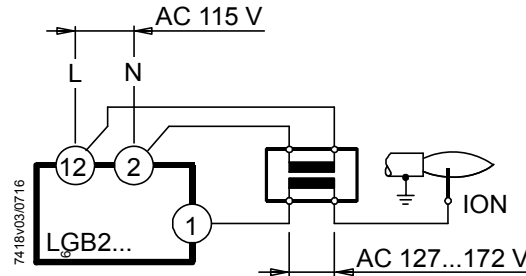

Function

The relevant function diagram shows the required or permissible input signals to the control section and to the flame supervision circuit hatched (refer to *Connection diagrams*).

If these input signals are not present, the burner control will stop the startup sequence to trigger lockout where required by safety regulations.

Startup

- Burner control reset
- The contacts of the gas pressure switch (GP), the limit thermostat / pressure switch (W), the control thermostat / pressurestat (R) and safety limit thermostat (SB) must be closed, heat request
- Fan motor (M) connected
- Air pressure switch (LP) is in idle position
- No undervoltage
- Flame detector darkened, no extraneous light

Undervoltage detection

An additional electronic circuit ensures that, if the mains voltage drops below approximately AC 165 V, the burner startup will be prevented or a lockout will be triggered.

Reversed polarity protection

If the connections of live conductor (terminal 12) and neutral conductor (terminal 2) have been mixed up, the burner control will initiate lockout at the end of the safety time (TSA).

Control sequence

(Times in seconds) ¹⁾

| | AC 220...240 V | LGA41.153A27 | LGA41.173A27 | LGA52.150B27 | LGA52.171B27 | LGA63.191A27 |
|--------------------|--------------------------------------|--------------|--------------|--------------|--------------|--------------|
| | AC 100...110 V | --- | --- | LGA52.150B17 | --- | --- |
| t1 | Prepurge time | --- | --- | Approx. 13 | Approx. 13 | Approx. 13 |
| t3 | Preignition time | 15 | 15 | --- | --- | --- |
| t3' | Preignition time from start of «TSA» | --- | --- | Max. 5 | 4.5...7.5 | Max. 10 |
| TSA | Ignition safety time | 5 | 10 | 5 | 4.5...7.5 | 10 |
| TSAm _{ax} | Max. ignition safety time | 10 | 20 | 10 | 20 | 20 |
| t3n | Postignition time | Max. 2 | Max. 2 | --- | --- | --- |
| t4 | Interval «BV1 – BV2» | Approx. 18 | Approx. 13 | Approx. 18 | Approx. 13 | Approx. 23 |

¹⁾ All times specified apply to AC 220 V and AC 110 V respectively
For AC 240 V operations, above times are to be multiplied by 0.7

Function (cont'd)

Control sequence in the event of fault

If lockout occurs, the outputs for the fuel valves, the burner motor and the ignition equipment are immediately deactivated (<1 second).
 The lockout indication lamp changes to red and voltage is fed to terminal 10 (Alarm) for remote lockout indication.
 This state will also be maintained in the event of power failures.

| Cause | Response of LGA41... | Response of LGA52... / LGA63... |
|---|---|--|
| Erroneous flame signal during «t1» or «t3» (extraneous light) | Lockout ²⁾ prior to the release of gas | Lockout ²⁾ prior to ignition and the release of gas |
| No flame on completion of «TSA» | Lockout ²⁾ | Lockout ²⁾ |
| Loss of flame during operation | Repetition | Repetition |
| No air pressure signal during «t1» | --- | No start |
| Air pressure failure during operation | --- | Shutdown |

²⁾ After lockout, the burner control can be reset after about 60...90 seconds

Lockout

After lockout, the LGA will remain locked (lockout cannot be changed).
 This state will also be maintained in the event of power failures.

Resetting the burner control

After lockout, the burner control can be reset after 60...90 seconds (also refer to *Warning notes*).

Flame supervision with ionization probe

The conductivity and rectifying effect of hot flame gases are used for flame supervision. For that purpose, AC voltage is applied to the ionization probe which projects into the flame. The current that flows in the presence of a flame (ionization current) generates the flame signal which is then fed to the input of the flame signal amplifier. The amplifier is designed such that it only responds to the DC current component of the flame signal, thus ensuring that a short-circuit between ionization probe and ground cannot simulate a flame signal (since in that case, AC current would flow).

Function (cont'd)

Internal diagram
LGA41...

When the switch-on command is given, power is supplied to the ignition transformer and the heating coil of the bimetal sequencing device. The bimetal bends and pushes contact set «c, d, e» towards «f». On completion of the preignition time, the system tilts so that «e - f» closes and «f - g» opens, «BV1» receives voltage. Contacts «c - d» still remain closed («c» resting on «d»). On flame establishment, the flame relay is energized, latching mechanically «e - f» in the position now assumed. The relay also closes contact «f» and, at the same time, opens «c - d», so that the ignition transformer and the bimetal heating element will be switched off. Then, «d» slowly returns to its starting position, also catching «g». When tilting back, «g - f» closes, so that the main valve «BV2» will be energized.

If no flame signal is generated, the flame relay does not open «c - d», so that the bimetal will continue to be heated. The bimetal thus continues to bend until – tilting – it actuates contact «tz2»: → Lockout.

In the event of an erroneous premature flame signal, the flame relay – by means of its latch – prevents «e - f» from making, which means no release of fuel. «TZ», however, still receives power so that the bimetal continues to bend until, eventually; lockout is initiated by «tz2».

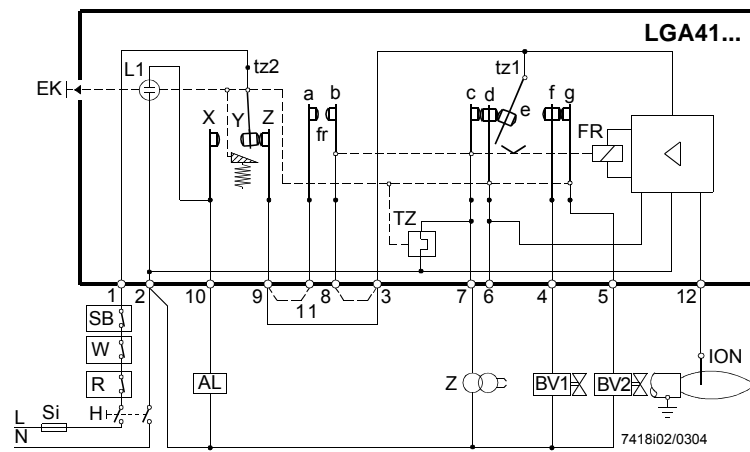

Legend

| | | | |
|-------|-------------------------------|----|--|
| AL | Fault status signal | R | Thermostat or pressurestat |
| BV... | Fuel valve | SB | Safety limit thermostat |
| EK | Lockout reset button | Si | External primary fuse |
| ION | Ionization probe | TZ | Electro-thermal timer (bimetal system) with contacts «tz» |
| FR | Flame relay | W | Limit thermostat / pressure switch |
| L1 | Built-in lockout warning lamp | Z | Ignition transformer |
| H | Main switch | | |

Function (cont'd)

Internal diagram
LGA52... / LGA63...

When the switch-on command is given, the auxiliary fan starts to run. When the air pressure switch closes its contact, the heating coil of the bimetal sequencing device is energized and the bimetal pushes contact set «c, d, e» towards «f» (thereby opening «f - g»). On completion of the prepurge time, «e - f» is closed so that both fuel valve «BV1» and the ignition transformer receive voltage: The safety time starts. On flame establishment, the flame relay latches mechanically «e - f», pushes «c» back at the same time and opens «fr». The ignition transformer is thus switched off and the heating coil deenergized, so that «d» can revert to its starting position. When tilting back, «g - f» closes so that the main valve «BV2» receives voltage.

If no flame signal is generated, the flame relay does not open «c - d», so that the bimetal will continue to be heated. The bimetal thus continues to bend until – tilting – it actuates contact «tz2»: → Lockout

In the event of an erroneous premature flame signal, the flame relay – by means of its latch – prevents «e - f» from making, which means no release of fuel. «TZ», however, still receives power so that the bimetal continues to bend until, eventually; lockout is initiated by «tz2».

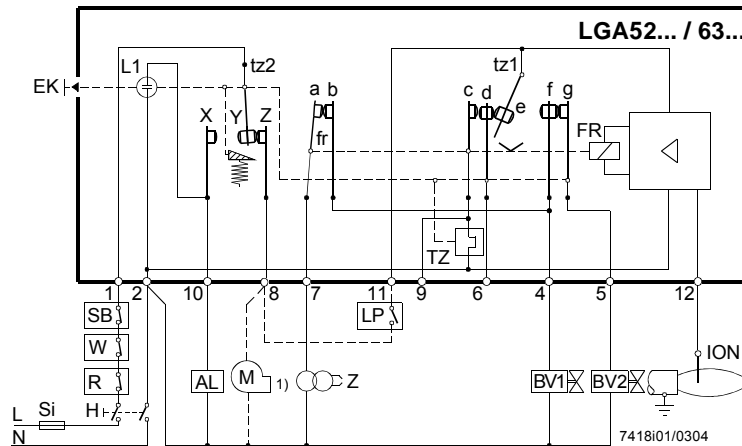

Legend

| | | | |
|-------|-------------------------------|----|--|
| AL | Fault status signal | H | Main switch |
| BV... | Fuel valve | M | Auxiliary fan |
| EK | Lockout reset button | R | Thermostat or pressurestat |
| ION | Ionization probe | SB | Safety limit thermostat |
| FR | Flame relay | Si | External primary fuse |
| L1 | Built-in lockout warning lamp | TZ | Electro-thermal timer (bimetal system) with contacts «tz» |
| LP | Air pressure switch | W | Limit thermostat / pressure switch |
| 1) | Not monitored to EN 298 | Z | Ignition transformer |

Connection diagram

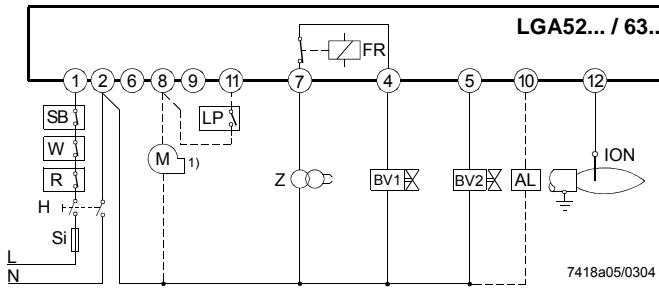
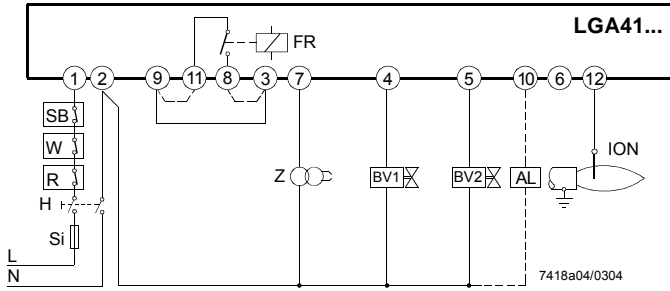

Program sequence

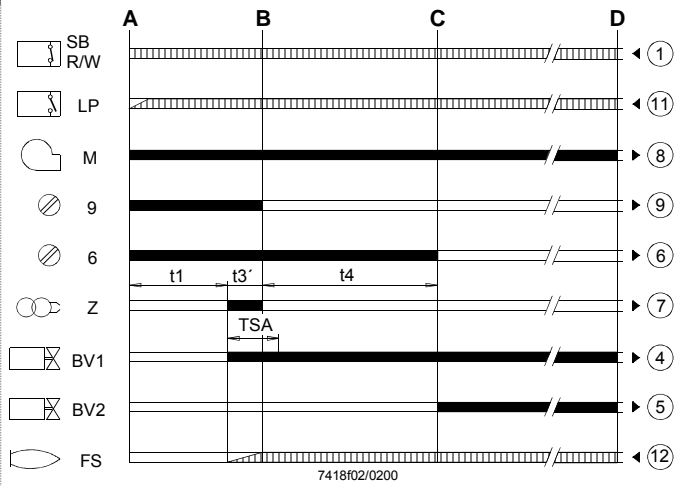
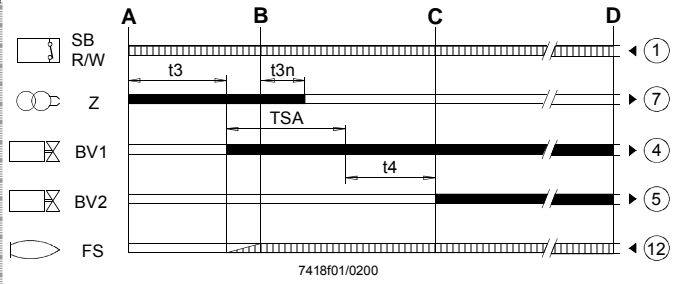

Legend

| | |
|-------|---------------------|
| AL | Fault status signal |
| BV... | Fuel valve |
| ION | Ionization probe |
| FR | Flame relay |
| FS | Flame signal |
| LP | Air pressure switch |
| H | Main switch |

| | |
|--|---------------------------------|
| | Required input signals |
| | Burner control's output signals |

| | |
|-----|--|
| A | Commencement of startup sequence |
| B | Time of flame establishment |
| t1 | Prepurge |
| t3 | Preignition time |
| t3' | Preignition time from the start of «TSA» |

| | |
|----|------------------------------------|
| M | Auxiliary fan |
| R | Thermostat or pressurestat |
| SB | Safety limit thermostat |
| Si | External primary fuse |
| W | Limit thermostat / pressure switch |
| Z | Ignition transformer |

| | |
|-----|----------------------------|
| 1) | Not monitored to EN 298 |
| C | Operating position |
| D | Controlled shutdown by «R» |
| t3n | Postignition |
| t4 | Interval «BV1 – BV2» |
| TSA | Ignition safety time |

Dimensions

Dimensions in mm

LGA...



Plug-in base AGK11...

